

4 WIRE APARTMENT SYSTEM MONITOR

KCV-504·D504

- 7" Color digital LCD monitor
- Easy to operate using OSD menu and icon button
- Communication between Door camera, Guard phone and Lobby phone
- Connection up to 1 Door camera and 1 monitor

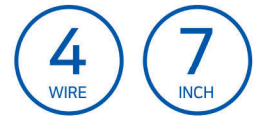

COLOR



BLACK



WHITE

SPECIFICATIONS

Model No.	KCV-504	KCV-D504
Power Source	AC 100-240V, 50/60Hz	DC 15V-2A(JPW128KA1502N05)
Power Consumption	Stand by 1.5W, In load 11W(±20%)	
LCD	7" Digital LCD	
Communication System	Hands-free Type	
Operating Temperature	0°C ~ +40°C	
Mount Type	Surface mount	
Dimesion	223(W) x 130(H) x 26(D) mm	

WIRING DIAGRAM

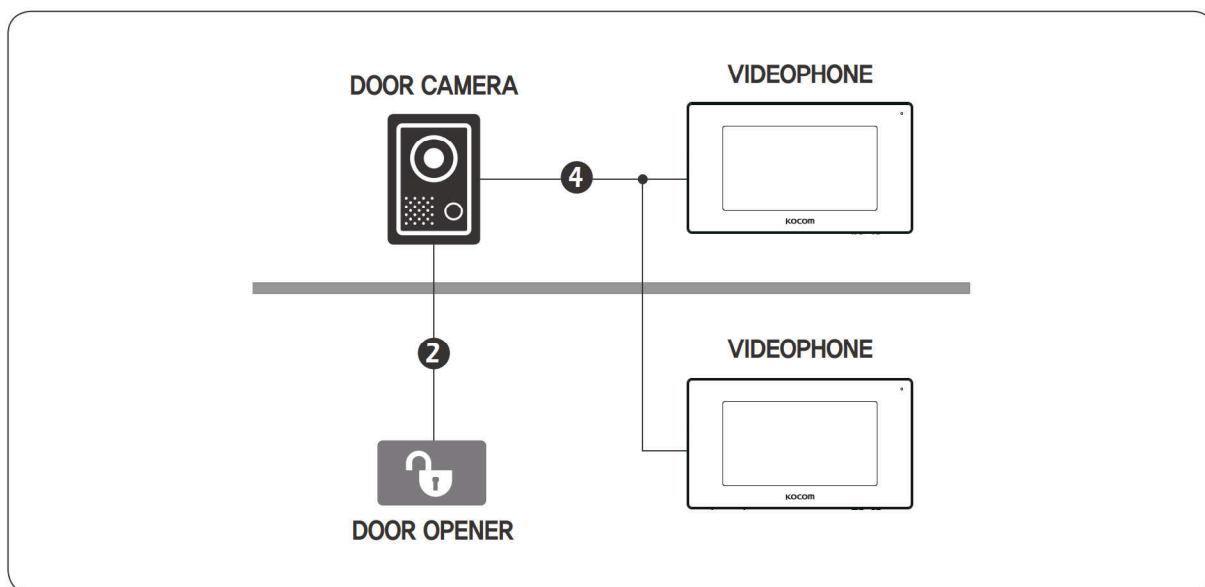

PRODUCT DIMENSION

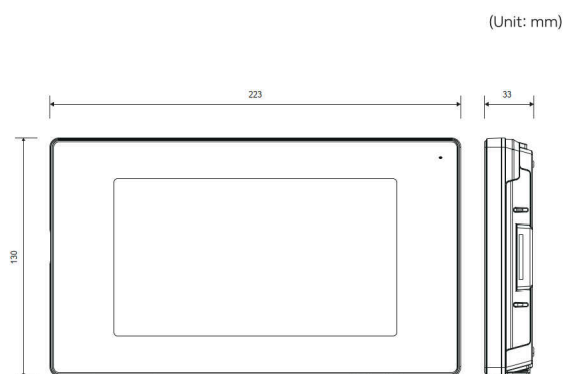

CONNECTABLE PRODUCT



DOOR CAMERA
KC-Q81P

- 4 WIRE
- SUNVISOR



SPECIFICATIONS

Power	DC 12V±1V(power from monitor)
Power Consumption	Max. 3W
Wiring	4 Wire
Body Material	Plastic
Mount Type	Surface mount
Camera Angle	100 ° (Angle Adjustable)
Min. Illumination	0.1 lux(LED ON)
Dimension	75(W) x 136.5(H) x 18.5(D)mm

WIRING

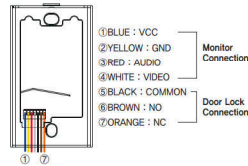

DOOR CAMERA
KC-MC24

- 4 WIRE



SPECIFICATIONS

Power	DC 12V±1V(power from monitor)
Power Consumption	Max. 2.5W
Wiring	4 Wire
Body Material	Metal
Mount Type	Surface mount
Camera Angle	90 ° (Fixed)
Min. Illumination	0.1 lux on the object(LED ON)
Dimension	95(W) x 127(H) x 32(D)mm

WIRING

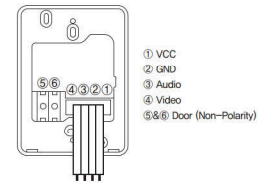

DOOR CAMERA
KC-MC20

- 4 WIRE
- SUNVISOR



SPECIFICATIONS

Power	DC 12V±1V(power from monitor)
Power Consumption	Consumption : Max. 2.5W
Wiring	4 Wire
Body Material	Metal
Mount Type	Surface mount
Camera Angle	90 ° (Fixed)
Min. Illumination	0.1 lux on the object(LED ON)
Dimension	40(W) x 120(H) x 22(D)mm

WIRING

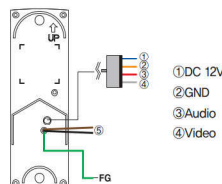

Full Mirror Front



26mm Ultra Slim Design



KCV-504/D504

 **Handsfree Videophone**
KCV-504/D504

Compact Slim Design(26mm) | 7 inch digital LCD color monitor | Full Mirror Front
Easy Icon Button | OSD function | Visitor Communication and Door Open
Communicate with Guard Master phone | Touch button | Guard Phone, Lobby Phone Operating

Monitor for KCV-504 / KCV-D504



Transparent(Black)

Transparent(White)

Mirror(Black)

Mirror(White)

Camera for KCV-504 / KCV-D504



KC-MC24

KC-C60

KC-MC20

KC-MC30

KLP-C410

System configurations (Cam Mode)

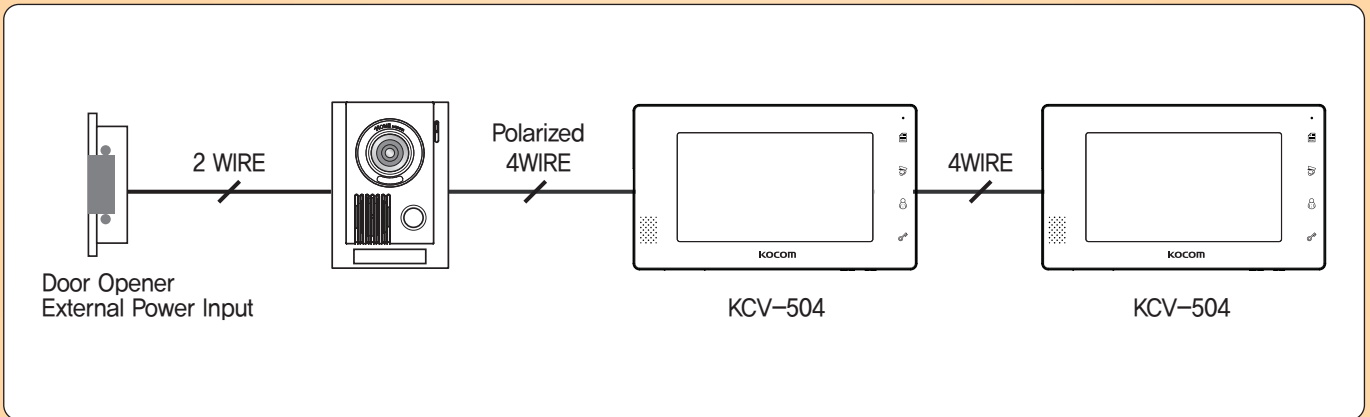

System configurations (System Mode)

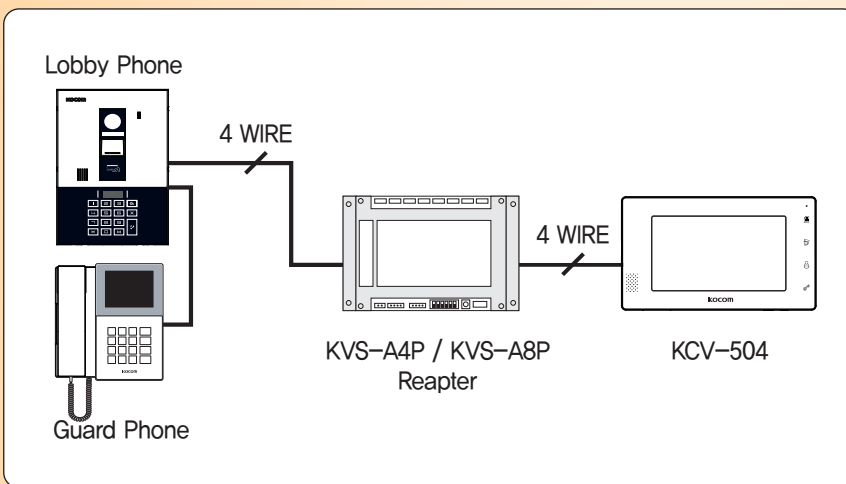

Camera connection wiring

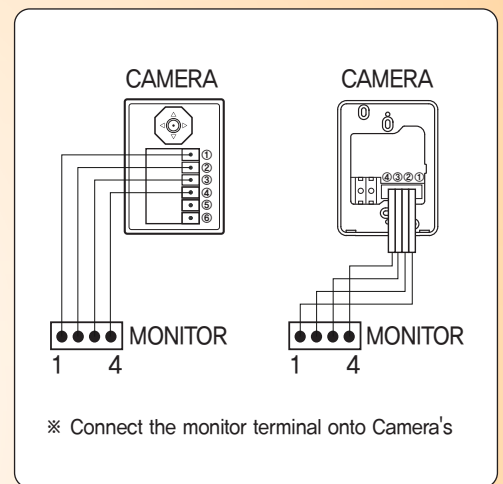

* Caution for Camera Installation

When turned on, the monitor automatically detects if video signal(CAM1) is NTSC or PAL.
So, after connecting camera(CAM1), the monitor should be turned on again.

Specifications

Monitor	Model number	KCV-504		KCV-D504	
	Power Source	AC90V-AC240V 50/60Hz		DC 15V-2A(JPW128KA1502N05)	
	Power Consumption	Stand by 1W, In load 8.5W(±20%)			
	Operating Temperature	0°C ~ +40°C			
	LCD	7 Inch color LCD			
	Communication System	Handsfree type			
	Wiring	Door camera wiring - Polarized 4 lines (VCC[12V] / GND / VOICE / VIDEO)			
	Mount Type	Surface mount			
Dimension	223(W) x 130(H) x 26(D) mm				
Door Camera	Model number	KC-MC30	KC-MC24	KC-C60	KC-MC20
	Power Source	DC 12V±1V(Power from Monitor)			
	Power Consumption	Max. 3W			
	Operating	-10°C ~ +50°C			
	Dimension	110(W) x 158(H) x 39(D)mm	96(W) x 127(H) x 32(D)mm	95(W) x 127(H) x 34(D)mm	40(W) x 120(H) x 22(D)mm
	Angle of Lens	Diagonal 120° (angle adjustable)	Diagonal 90°	Diagonal 90°	Diagonal 90°

* Door Camera Wiring - Polarized 4 lines (VCC[12V]/GND/VOICE/VIDEO)